

The Caustic Soda Solution Handbook

**Operating efficiently.
Operating safely.**

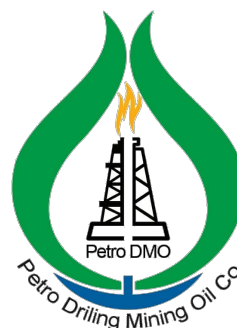

WWW.PETROCSC.COM
WWW.PETRODMO.COM
WWW.PETROGROUPECO.COM

Whats app: +989125325443
Office : +982122147345-6

Address: Block D 6th Floor Alame
Tower North Alame AV Saadat
Abbad Tehran-Iran

Good Chemistry at Work



Caustic Soda Solution Handbook

Contents	Page
Caustic Soda and Dow Product Stewardship . . .	3
Additional Information	3
Safety Precautions and Preventive Measures . . .	4
First Aid: What to do in case of an accident . . .	5
Spill Cleanup and Waste Disposal	5
Caustic Solution Forms	6
Caustic Soda Sampling	6
Caustic Soda Billing	6
Shipping Methods	7
Caustic Soda Dilution	8
Production and Distribution	10
Data on Physical Properties	11
Storage and Handling	19
Railway Tank Car Unloading	21
Tank Truck Unloading	25
Railway Tank Car Steaming	27

This brochure is also available in Spanish, Portuguese, and French (Canadian). Please request form numbers:

Español/Spanish	102-00422
Português/Portuguese	102-00421
Français/French	102-00348

See our web site located at www.dowcaustic.com for a complete listing of safety and handling literature and videos.

DANGER

Caustic soda in all forms is a highly corrosive material which can cause serious burns to the eyes and skin. Eye contact of only a few seconds can cause permanent damage, even blindness; short contact with the skin may cause marked irritation or chemical burn.

In all cases of bodily contact with caustic soda, begin washing **immediately** with large quantities of flowing water. Before working with caustic soda, all personnel should know where the nearest eyewash fountain and safety shower are located.

SPECIAL PRECAUTIONS FOR DILUTING CAUSTIC SODA SOLUTION:

1. **Always** add caustic soda solution to water with constant agitation. **Never** add water to the caustic soda solution.
2. The water should be lukewarm 80°–100°F (27°–38°C). **Never** start with hot or cold water.

The addition of caustic soda to liquid will cause a rise in temperature. If caustic soda becomes concentrated in one area, or is added too rapidly, or is added to hot or cold liquid, a rapid temperature increase can result in DANGEROUS mists or boiling or spattering, which may cause an immediate VIOLENT ERUPTION.

If there is any question regarding the use of caustic soda in a particular application, contact your Dow representative.

In case of emergencies involving exposures, leaks, or spills, call The Dow Chemical Company at: In the United States: (989) 636-4400
In Canada: (519) 339-3711 (Sarnia, Ontario)
(780) 998-8282 (Fort Saskatchewan, Alberta)

For transportation emergencies, in the U.S. call CHEMTREC at 1-800-424-9300, and in Canada call CANUTEC at (613) 996-6666.

CHEMTREC and CANUTEC will provide initial guidelines and then call the manufacturer.

Caustic Soda and Dow Product Stewardship

Caustic soda or sodium hydroxide (NaOH) is chemically reactive with a wide variety of organic and inorganic chemicals. In all its forms, including solution form, caustic soda is highly corrosive and can cause serious burns to the eyes and skin. Eye contact of only a few seconds can cause permanent damage, even blindness. Short contact with the skin can cause marked irritation or a chemical burn. (See “Danger” on page 2.)

The hazards of working with caustic soda make it important that all persons handling caustic soda, either directly or indirectly, know and follow strict procedures for safety. Companies using caustic soda are urged to inform and train their employees on appropriate safety practices and first aid.

Periodic safety meetings and safety inspections are recommended to minimize the hazards of caustic soda. Safety meetings should serve to remind all employees of the safe handling procedures you have developed, ensure their compliance with the precautions and practices required to handle caustic soda safely, and reinforce previous training in what to do in the event of an accident.

The Responsible Care® Commitment

Dow people around the world develop solutions for society based on Dow’s inherent strength in science and technology. For over a decade, we have embraced and advocated Responsible Care—a voluntary, industry-wide commitment to safely handle our chemicals from inception in the laboratory to ultimate disposal. This worldwide commitment helps consumers lead better lives, customers succeed, stockholders prosper, employees achieve, and communities thrive.

Dow’s chlor-alkali product and environmental stewardship program is part of that worldwide commitment. The stewardship program for caustic soda is a comprehensive program of safety literature and materials, training aids, regulatory and environmental information, and other stewardship resources available to all Dow customers. It is designed to provide all users of DOW* caustic soda with materials they may need to use, and dispose of caustic soda safely and responsibly.

Responsible Care® is a registered service mark of The American Chemistry Council.

*Trademark of The Dow Chemical Company

For additional information on caustic soda and related products, contact:

The Chlorine Institute
2001 L Street NW, Suite 506
Washington, DC 20036
Phone: (703) 741-5760
Fax: (703) 741-6068
www.cl2.com

Caustic Soda Pamphlets of Interest

1. Pamphlet 065: “Personal Protective Equipment for Chlor-Alkali Chemicals.” Provides information pertaining to certain personal protective equipment used in the manufacture or handling of chlorine and sodium hydroxide.
2. Pamphlet 087: “Recommended Practices for Handling Sodium Hydroxide Solution and Potassium Hydroxide Solution (caustic) Tank Cars.” Guidelines, recommended practices, and other useful information for the safe shipping, handling, and/or receiving of sodium hydroxide solution in tank cars.
3. Pamphlet 088: “Sodium Hydroxide Solution and Potassium Hydroxide Solution (caustic): Tank Motor Vehicle Load/Unload.” Guidelines, recommended practices, and other useful information for the safe shipping, handling, and receiving of sodium hydroxide solution and potassium hydroxide solution.
4. Pamphlet 094: “Sodium Hydroxide Solution and Potassium Hydroxide Solution (caustic): Storage Equipment and Piping Systems.” Information concerning the storage and piping of sodium hydroxide and potassium hydroxide solutions, as well as practical suggestions in the design, construction, and operation of these systems.

These resource materials and other industry information can be obtained through The Chlorine Institute web site:

www.cl2.com/publications/index.html
or send your request via fax to (703) 741-6068.

Safety Precautions and Preventive Measures

The Basic Challenge

Caustic soda solution is a very corrosive industrial chemical. While it does not look dangerous, having the appearance of water, eye contact of only a few seconds can cause permanent damage, even blindness.

Caustic soda is odorless, so odor cannot serve as a warning. In addition, caustic soda doesn't cause immediate pain when it comes in contact with the skin, but it does cause immediate damage. Brief contact with the skin may cause marked irritation or a chemical burn.

Upon bodily contact, caustic soda will continue to attack and penetrate the eyes or skin (unlike acids that coagulate protein to form a barrier). This means that:

- Following eye contact, you must start washing with water immediately to prevent permanent damage. Therefore, eyewash fountains should be located near any caustic soda handling area.
- Following skin contact, you must start washing with water immediately to prevent slow-healing chemical burns. Therefore, safety showers should be located directly above the eyewash fountains.

Protective Clothing and Equipment

All personnel handling caustic soda must wear the proper protective clothing. For additional information, review Pamphlet 065 from The Chlorine Institute. See page 3 for ordering details.

1. Persons handling caustic soda must always wear close-fitting chemical worker's safety goggles and chemical resistant gloves.
2. Additional clothing and equipment may be required, depending on the job. See Figure 1. It is the responsibility of the facility using caustic soda solution to perform a job safety analysis to determine the proper Personal Protective Equipment (PPE) for the task being performed. These options may include:
 - Hard hat.
 - Chemical resistant apron.
 - Full face shield (in addition to chemical worker's safety goggles).
 - Chemical resistant boots.
 - Chemical protective suit (jacket and pants). The jacket should be buttoned up to the neck, the trousers worn outside the boots, and the shirt sleeves sealed at the glove unless a job safety analysis determines it is acceptable for the sleeve to be worn over the glove.
 - Full chemical protective suit with hood and an air supplied respirator.

Figure 1 Protective Clothing and Equipment for Handling of Bulk Caustic Soda Solution.

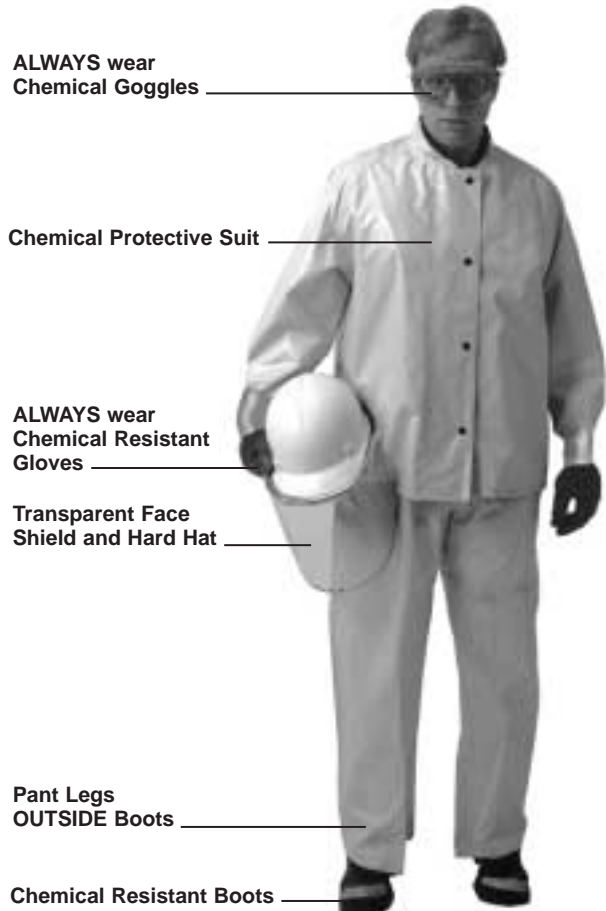

Caustic soda can cause severe skin or eye damage (including blindness) with only brief contact. All personnel handling bulk caustic soda must wear proper protective clothing. Safety goggles and chemical resistant gloves are required at all times. A hard hat, face shield, chemical protective suit, and chemical resistant boots may be required for some jobs. During an emergency, a full chemical protective suit with hood and an air supplied respirator may also be needed.

3. Workers should be thoroughly trained regarding the hazards of caustic soda before starting any work involving the material (unloading, storage, transferring, production, maintenance, lab testing, etc.). All such activities should be carefully planned in advance, and all planned procedures must be carefully followed.

First Aid: What to do in case of an accident

Caustic soda must be removed as quickly as possible after bodily contact by washing with water only. Do not use soap. Do not attempt to neutralize the caustic soda with chemicals. Continue washing for 30 minutes or until advised to cease by a physician. *It is important to immediately contact a physician for any exposure to caustic soda.* Follow the advice of the physician. It is imperative that you begin to wash with water as soon as possible. Any time lost prior to such washing with water could cause serious and irreparable damage!

Eyewash fountains should be located near any caustic soda handling area. Safety showers should be located directly above the eyewash fountains.

- 1. Eyes:** Wash immediately with water under low pressure from an eyewash fountain. After hands have been thoroughly rinsed, hold the eyelids open and continue washing for 30 minutes or until advised otherwise by a physician.
- 2. Body:** Wash immediately with water from a safety shower. Wash the affected skin with water for 30 minutes. Remove clothing while showering. If the eyes have not been exposed, do not remove your goggles until your head and hair have been thoroughly rinsed, otherwise, caustic soda could be washed into the eyes. Rinse your head thoroughly, then remove the goggles, and complete washing.
- 3. Ingestion (swallowing):** Do not induce vomiting. Immediately drink large quantities of milk (preferable) or water and call a physician.
- 4. Clothing:** Wash contaminated clothing to remove caustic soda before reuse. Contaminated shoes and leather items should be destroyed.

Contact a physician immediately for any exposure to caustic soda and start washing with water right away.

Spill Cleanup and Waste Disposal

SEE SAFETY PRECAUTIONS SECTION
ON PAGE 4 BEFORE STARTING SPILL
CLEANUP EFFORTS:

Small Spills (in contained area)

1. Carefully dilute with water.
2. Neutralize with weak (acetic) acid if necessary.
3. Vacuum up for reuse or disposal.

Large Spills (in contained area)

1. Transfer as much as possible to secure containers for reuse or disposal.
2. Carefully dilute remaining caustic with water.
3. Neutralize with weak (acetic) acid if necessary.
4. Vacuum up diluted and neutralized solution for reuse or disposal.

Spills in Uncontained Areas (e.g., soil, gravel, etc.)

1. Contain spill and vacuum up as much caustic as possible for reuse or disposal.
2. Dig up contaminated soil or gravel for disposal.

Always follow all regulations governing disposal. Never discharge waste caustic directly into sewers or streams.

Releases (spills) of caustic soda to the environment may trigger reporting requirements to federal, state, provincial, and local authorities.

In the U.S., spill reports to the National Response Center (1-800-424-8802) will comply with federal reporting requirements under CERCLA and SARA regulations. The U.S. Coast Guard may also need to be notified under the Clean Water Act.

In Canada, federal and provincial laws require immediate reporting of certain caustic soda spills. Users and handlers of caustic must know and comply with these requirements.

For all other countries, contact your local Dow representative or the Dow regional office (phone numbers are provided on the back cover of this brochure).

If a Dow tank car or truck is involved in a spill, notify Dow by calling the emergency response numbers stenciled on the tank car or printed on the bills of lading.

Caustic Solution Forms

Commercial Grade Caustic Soda Solution

Most users of caustic soda will find that 50% diaphragm grade solution is the most convenient and economical form of caustic soda to buy.

50% Membrane/Low Salt Grade Caustic Soda Solution

While normal diaphragm cell caustic soda contains about 1% salt (NaCl), membrane/low salt caustic soda contains less than 0.01% NaCl. Dow's membrane/low salt caustic soda can be substituted for mercury cell grade caustic in virtually all applications. In some areas, "membrane caustic" is also referred to as "low salt caustic."

Caustic Soda Billing

Because of small variations in the alkali concentration of shipments of 50% caustic soda solutions, a standard billing basis is necessary. In Canada, U.S., and Mexico, Dow's practice is to base the billing weight of each shipment on its sodium oxide (Na₂O basis), by the following formula:

$$\frac{\text{lbs solution} \times \text{Na}_2\text{O content (\%)}}{76 \times 2000} = \text{net tons total alkalinity as NaOH (76\% Na}_2\text{O basis)}$$

$$\frac{\text{kilos solution} \times \text{Na}_2\text{O content (\%)}}{76 \times 1000} = \text{net metric tons total alkalinity as NaOH (76\% Na}_2\text{O basis)}$$

The cost of the material (e.g., \$/ton, 76% Na₂O basis) is then computed by multiplying the net tons (or net kilos) of total alkalinity (76% Na₂O basis) by the current price.

Caustic Soda Sampling

General Information

It is always advisable to positively identify the caustic soda before it is unloaded. Dow produces caustic soda using SPC (Statistical Process Control) and SQC (Statistical Quality Control) methods. Copies of SQC charts for sales specification items can be obtained from your Dow sales representative.

If a retainer sample is taken, it must be representative of the entire shipment. Since impurities (especially sodium carbonate) tend to concentrate at the top or bottom of the container, dipping caustic from the surface will not provide a representative sample. To be representative, the sample must include material from every level of the tank car or tank truck.

As caustic soda solution freezes, the caustic soda concentration changes in both the solid and liquid phases. This is also true of the impurities present. Consequently, a shipment of partially frozen caustic should be thoroughly thawed before a sample is taken.

Sampling 50% Caustic Soda

Commercial samplers are available from chemical equipment supply houses. However, a representative sample can be obtained by rapidly lowering a weighted, small-necked bottle to the bottom of the shipping container and then retrieving it. Caustic soda will bubble into the bottle as it is raised, giving a vertical cross-section sample of the container's entire contents.

The caustic enters the sampler continuously from the various depths through which it passes. In order to obtain a sample representative of the shipment, the sampler must be kept in motion. The sampling device should then be thoroughly rinsed with water to remove all caustic after each use. Some means should be provided for collecting and safely disposing of all rinsings.

Dissolving or Diluting Samples

Always use distilled or deionized water to dilute or dissolve caustic soda samples being prepared for chemical analysis. To avoid splattering and possible violent eruption, caustic soda should be added to water slowly and with continuous mixing.

Shipping Methods

Tank Cars/Tank Trucks

Each Dow manufacturing point maintains a fleet of insulated and lined tank cars equipped with suitable heating coils for caustic soda service.

Tank cars are equipped to allow unloading from the top or bottom by pump or air pressure. Safety valves are provided to help prevent injuries to personnel resulting from excessive air pressure. All tank cars are carefully maintained. Before each loading they are carefully inspected, and any necessary washing and repairs are carried out.

Tank trucks are also available for 50% caustic soda service at all shipping locations. They are of stainless steel construction, or lined to preserve product quality. Where weather conditions require, tank trucks are insulated.

DOW caustic soda can be shipped in tank cars or tank trucks in the quantities shown in Table 1 and Table 2.

For additional information, review Pamphlet 087 (for tank cars) and 088 (for tank trucks) from The Chlorine Institute. See page 3 for details.

Table 1 Rail Car Shipments

Size of Car	Approximate Solution Wt.		Approximate Dry Wt.	
	Gallons	Lbs.	Kilos	Lbs.
16,000	200,000	90909	100,000	45454

Table 2 Tank Truck Shipments

Size of Truck—U.S.	Size of Truck—Canada		Approximate Solution Wt.		Approximate Dry Wt.	
	Gallons	Solution Metric Tons	Dry Metric Tons	Lbs.	Kilos	Lbs.
4,000	22	11	48,400	22000	24,200	11000
—	36	18	79,200	36000	39,600	18000
—	40	20	88,000	40000	44,000	20000

Caustic Soda Dilution

Mixing Chart for Caustic Soda Solutions

The mixing chart (Figure 2) is helpful in estimating the volume of water needed to dilute concentrated caustic solutions to desired concentrations, or volumes of caustic solutions of different concentrations to mix together to produce solutions of desired intermediate concentrations.

SPECIAL PRECAUTIONS FOR DILUTING CAUSTIC SODA SOLUTION:

1. **Always** add caustic soda solution to water with constant agitation. **Never** add water to the caustic soda solution.
2. The water should be lukewarm 80°–100°F (27°–38°C). **Never** start with hot or cold water.

The addition of caustic soda to liquid will cause a rise in temperature. If caustic soda becomes concentrated in one area, or is added too rapidly, or is added to hot or cold liquid, a rapid temperature increase can result in **dangerous** mists or boiling and spattering, which may cause an immediate **violent eruption**.

Example 1

How many gallons of 50% caustic soda must be added to 400 U.S. gal (1.51m³) of 20% to give a final concentration of 25%?

Connect 50% on the left (concentrated solution) scale with 20% on the right (dilute solution) scale. The point at which this line intersects the 25% solution scale shows that a ratio of 14 volumes of 50% caustic soda solution must be added to 86 volumes of 20% caustic soda solution. Using this volume ratio, set up an equivalence statement:

$$\frac{14 \text{ gal } 50\%}{86 \text{ gal } 20\%} = \frac{X \text{ gal } 50\%}{400 \text{ gal of } 20\%}$$

Solving for X

$$X = \frac{14 \times 400}{86} = \frac{65.1 \text{ U.S. gal (0.246m}^3\text{)}}{50\% \text{ caustic soda}}$$

Example 2

How much water should be mixed with 4.0m³ (1,057 gal) of 20% caustic soda to dilute it to 15%?

Connect 20% on the left (concentrated solution) scale with 0% (dilute solution) on the right scale. Where this line intersects the 15% scale, we find 72.5 volumes of 20% caustic soda solution and 27.5 volumes of water will yield a 15% caustic soda solution. Using this volume ratio, set up an equivalence statement:

$$\frac{27.5\text{m}^3 \text{ water}}{72.5\text{m}^3 \text{ 20\%}} = \frac{X \text{ m}^3 \text{ water}}{4.0\text{m}^3 \text{ of } 20\%}$$

Solving for X

$$X = \frac{27.5 \times 4.0\text{m}^3}{72.5} = \frac{1.51\text{m}^3 \text{ (399 gal)}}{\text{water needed}}$$

Figure 2 Mixing Chart for Caustic Soda Solutions

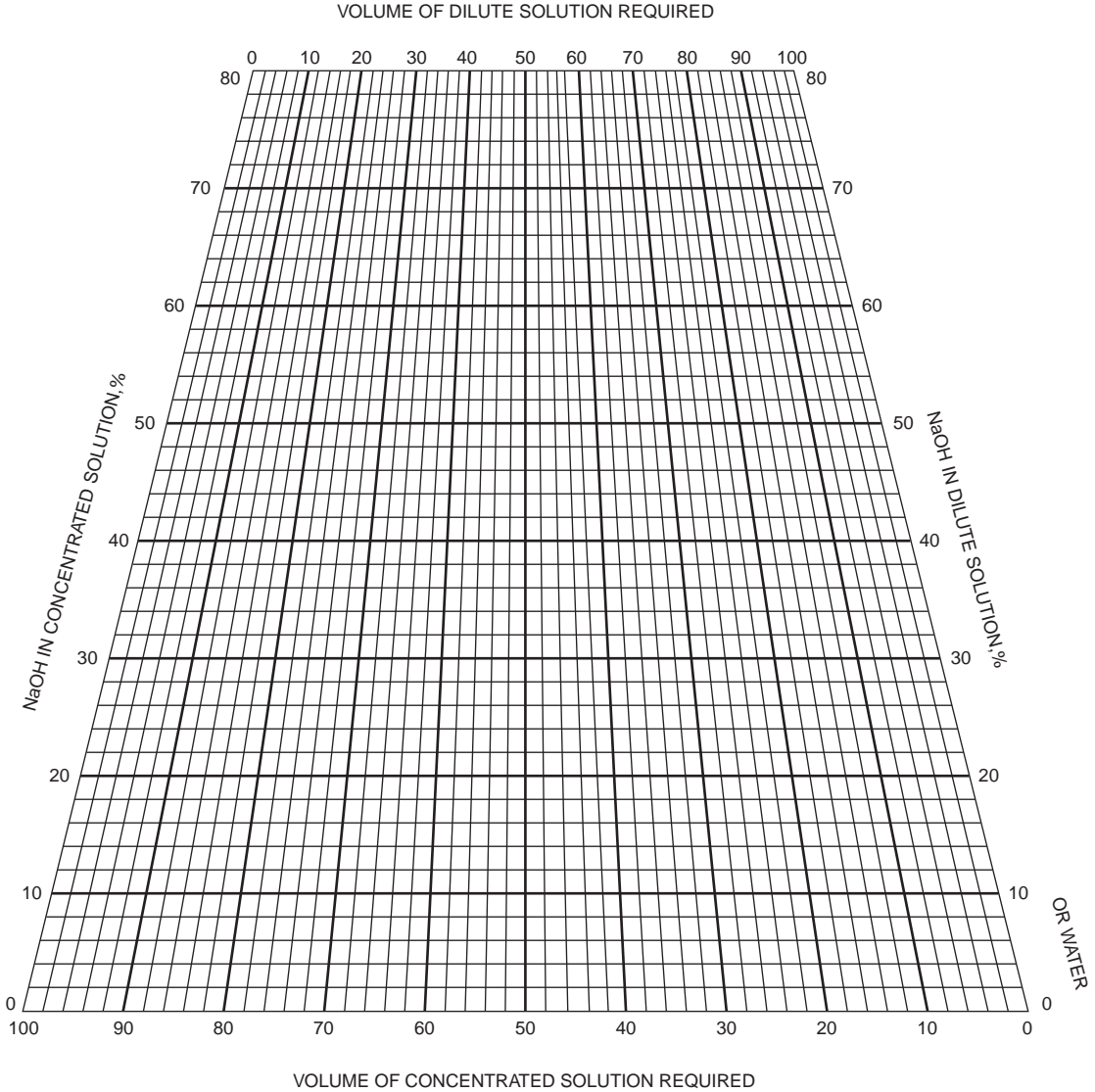

Production and Distribution

Dow has facilities for the production and distribution of caustic soda throughout the world. They are located to provide convenient delivery and maximum service to customers. Dow's terminals and production locations offer flexibility for caustic soda shipping.

For additional information on locations, contact your Dow seller or call the number for your area listed on the back of this brochure.

Data on Physical Properties

Figure 3 Freezing Points of Caustic Soda Solutions

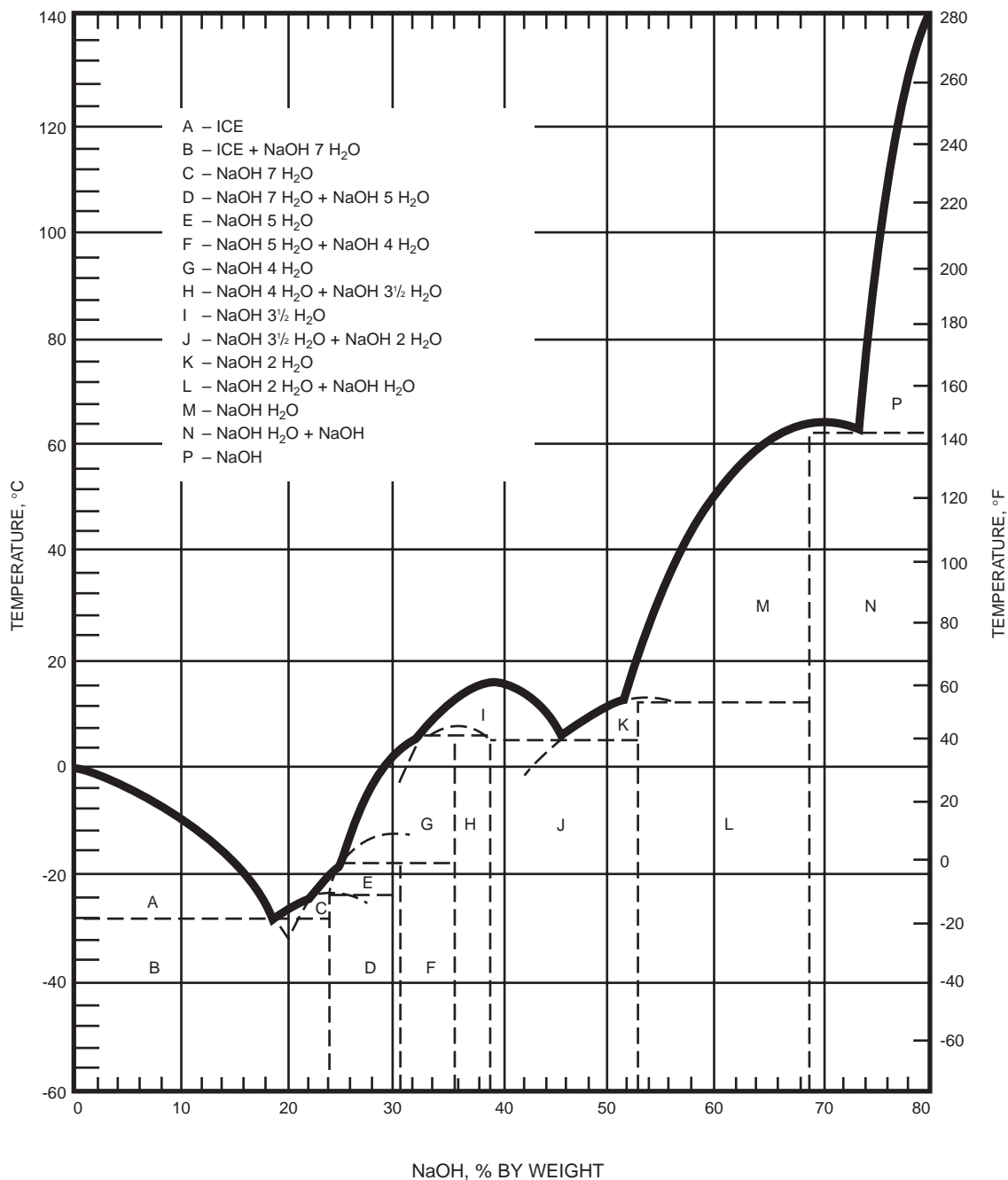

NOTE:

THE CURVE INDICATES THE POINT AT WHICH CRYSTALS EXIST IN CONTACT WITH SOLUTION.

From T.P. HOU, *Manufacture of Soda Ash*, 2nd Ed. N.Y., Reinhold Publishing Corp., 1942.

From *Industrial Engineering Chemistry*, Vol. 46, No 11, p. 2401.

Table 3 Specific Gravity-Concentration Table for Caustic Soda Solutions at 60°F (15.6°C)

% NaOH	% Na ₂ O	Specific Gravity 60/60°F	Baume Am. Std.	Degrees Twaddell 60°F	NaOH lb/gal	Total wt. Solution ⁽¹⁾ lb/gal	NaOH lb/G ⁽²⁾	Total wt. Solution ⁽³⁾ lb/G ⁽²⁾	Total wt. NaOH g/liter	Total wt. Solution ⁽³⁾ g/liter	NaOH lb/ft ³	Total wt. Solution ⁽¹⁾ lb/ft ³
1	0.78	1.012	1.72	2.4	0.08	8.44	0.10	10.14	10.11	1011.36	0.63	63.14
2	1.55	1.023	3.26	4.6	0.17	8.53	0.20	10.24	20.44	1022.14	1.28	63.81
3	2.32	1.034	4.77	6.8	0.26	8.62	0.31	10.35	30.99	1032.93	1.93	64.49
4	3.10	1.045	6.25	9.0	0.35	8.72	0.42	10.47	41.77	1044.91	2.61	65.23
5	3.87	1.056	7.69	11.2	0.44	8.81	0.48	10.57	52.77	1055.69	3.29	65.91
6	4.65	1.067	9.10	13.4	0.53	8.90	0.64	10.69	63.99	1066.48	3.99	66.58
7	5.42	1.079	10.65	15.8	0.63	9.00	0.76	10.80	75.44	1078.46	4.71	67.33
8	6.20	1.090	11.97	18.0	0.73	9.09	0.88	10.92	87.10	1089.25	5.44	68.00
9	6.98	1.101	13.30	20.2	0.83	9.18	1.00	11.02	98.99	1100.03	6.18	68.68
10	7.75	1.112	14.40	22.4	0.93	9.27	1.12	11.13	111.1	1110.81	6.94	69.35
11	8.52	1.123	15.88	24.6	1.03	9.36	1.23	11.24	123.5	1121.60	7.70	70.02
12	9.30	1.134	17.13	26.8	1.13	9.46	1.36	11.36	135.9	1133.58	8.49	70.77
13	10.08	1.145	18.36	29.0	1.24	9.55	1.49	11.47	148.9	1144.37	9.30	71.44
14	10.85	1.156	19.57	31.2	1.34	9.64	1.62	11.58	161.7	1155.15	10.10	72.12
15	11.62	1.167	20.75	33.4	1.46	9.73	1.75	11.68	175.0	1165.94	10.92	72.79
16	12.40	1.178	21.91	35.6	1.57	9.82	1.89	11.80	188.4	1176.72	11.76	73.46
17	13.17	1.190	23.15	38.0	1.69	9.92	2.03	11.91	202.1	1188.70	12.61	74.21
18	13.95	1.201	24.27	40.2	1.80	10.02	2.16	12.03	215.9	1200.69	13.47	74.96
19	14.73	1.212	25.36	42.4	1.91	10.11	2.30	12.14	229.1	1211.47	14.31	75.63
20	15.50	1.223	26.45	44.6	2.04	10.20	2.45	12.25	244.3	1222.26	15.26	76.31
21	16.28	1.234	27.50	46.8	2.16	10.29	2.59	12.36	258.9	1233.04	16.15	76.98
22	17.05	1.245	28.53	49.0	2.28	10.38	2.74	12.47	273.6	1243.83	17.08	77.65
23	17.83	1.256	29.55	51.2	2.41	10.48	2.90	12.59	288.6	1255.81	18.01	78.40
24	18.60	1.267	30.56	53.4	2.53	10.57	3.04	12.70	303.7	1266.59	18.96	79.07
25	19.38	1.278	31.57	55.6	2.66	10.66	3.20	12.80	319.2	1277.38	19.93	79.75
26	20.15	1.289	32.51	57.8	2.79	10.75	3.35	12.91	334.8	1288.16	20.90	80.42
27	20.92	1.300	33.46	60.0	2.93	10.85	3.52	13.03	350.7	1300.14	21.88	81.17
28	21.70	1.310	34.31	62.0	3.06	10.93	3.67	13.13	366.6	1309.76	22.89	81.77
29	22.48	1.321	35.23	64.2	3.19	11.02	3.83	13.23	382.8	1320.52	23.90	82.44
30	23.25	1.332	36.14	66.4	3.33	11.11	4.00	13.34	399.2	1331.30	24.92	83.11
31	24.02	1.343	37.03	68.6	3.47	11.20	4.17	13.46	416.0	1342.08	25.97	83.79
32	24.80	1.353	37.83	70.6	3.61	11.29	4.34	13.56	432.6	1352.87	27.00	84.46
33	25.58	1.363	38.62	72.6	3.75	11.37	4.50	13.65	449.7	1362.46	28.08	85.06
34	26.35	1.374	39.47	74.8	3.89	11.46	4.67	13.76	466.7	1373.24	29.13	85.73
35	27.12	1.384	40.23	76.8	4.04	11.54	4.85	13.86	484.4	1382.83	30.23	86.33
36	27.90	1.394	40.98	78.8	4.20	11.62	5.04	13.95	501.5	1392.41	31.30	86.93
37	28.68	1.404	41.72	80.8	4.33	11.71	5.20	14.06	519.4	1403.20	32.41	87.60
38	29.45	1.415	42.53	83.0	4.48	11.80	5.38	14.17	537.1	1413.98	33.52	88.28
39	30.22	1.425	43.24	85.0	4.63	11.88	5.56	14.27	553.3	1423.57	34.66	88.88
40	31.00	1.434	43.88	86.8	4.78	11.96	5.74	14.36	573.3	1433.15	35.79	89.47
41	31.78	1.444	44.58	88.8	4.93	12.04	5.92	14.46	591.6	1442.74	36.92	90.07
42	32.55	1.454	45.28	90.8	5.09	12.12	6.11	14.55	610.2	1452.33	38.10	90.67
43	33.32	1.463	45.89	92.6	5.25	12.20	6.30	14.66	629.5	1461.91	39.29	91.27
44	34.10	1.473	46.56	94.6	5.40	12.28	6.48	14.75	647.6	1471.50	40.41	92.87
45	34.88	1.483	47.22	96.6	5.54	12.37	6.65	14.86	667.8	1482.28	41.68	92.54
46	35.65	1.492	47.82	98.4	5.72	12.45	6.87	14.96	685.9	1491.87	42.80	93.14
47	36.42	1.502	48.46	100.4	5.89	12.53	7.07	15.05	705.9	1501.46	44.05	93.74
48	37.20	1.511	49.04	102.2	6.05	12.60	7.27	15.13	724.8	1509.85	45.27	94.26
49	37.98	1.521	49.67	104.2	6.22	12.68	7.47	15.23	744.8	1519.43	46.50	94.86
50	38.75	1.530	50.23	106.0	6.38	12.76	7.66	15.32	764.5	1529.02	47.73	95.46
51	39.52	1.540	50.84	106.0	6.55	12.84	7.87	15.42	784.3	1536.60	48.98	96.06
52	40.30	1.549	51.39	109.8	6.72	12.92	8.07	15.52	804.4	1548.19	50.23	96.65

⁽¹⁾Based on water at 8.329 lb/gal

⁽²⁾Imperial gallon

⁽³⁾Based on water at 998.05 g/liter

Table 4 Densities¹ of Caustic Soda Solutions at Various Temperatures

% NaOH	32°F 0°C	50°F 10°C	86°F 30°C	104°F 40°C	122°F 50°C	158°F 70°C	176°F 80°C	194°F 90°C	212°F 100°C
2	1.024	1.023	1.018	1.014	1.010	0.999	0.993	0.987	0.980
4	1.048	1.046	1.039	1.035	1.031	1.020	1.014	1.008	1.001
6	1.071	1.068	1.061	1.056	1.052	1.041	1.035	1.028	1.022
8	1.094	1.091	1.083	1.078	1.073	1.062	1.056	1.050	1.043
10	1.117	1.113	1.104	1.100	1.094	1.083	1.077	1.071	1.064
12	1.140	1.136	1.126	1.121	1.116	1.104	1.098	1.092	1.086
14	1.162	1.158	1.148	1.143	1.137	1.126	1.120	1.113	1.107
16	1.185	1.180	1.170	1.165	1.159	1.147	1.141	1.134	1.128
18	1.207	1.202	1.192	1.186	1.181	1.169	1.162	1.156	1.149
20	1.230	1.224	1.214	1.208	1.202	1.190	1.183	1.177	1.170
22	1.252	1.247	1.245	1.230	1.224	1.211	1.205	1.198	1.191
24	1.274	1.269	1.257	1.251	1.245	1.232	1.226	1.219	1.212
26	1.296	1.291	1.279	1.273	1.267	1.254	1.247	1.241	1.234
28	1.318	1.312	1.300	1.294	1.288	1.275	1.268	1.262	1.255
30	—	1.334	1.322	1.315	1.309	1.296	1.289	1.282	1.276
32	—	1.355	1.343	1.336	1.330	1.317	1.310	1.303	1.296
34	—	—	1.363	1.357	1.350	1.337	1.330	1.323	1.316
36	—	—	1.384	1.377	1.370	1.357	1.350	1.343	1.336
38	—	—	1.404	1.397	1.390	1.376	1.370	1.363	1.356
40	—	—	1.423	1.416	1.410	1.396	1.389	1.382	1.375
42	—	—	1.443	1.436	1.429	1.415	1.408	1.401	1.394
44	—	—	1.462	1.455	1.448	1.434	1.427	1.420	1.413
46	—	—	1.481	1.473	1.466	1.452	1.445	1.438	1.432
48	—	—	1.500	1.492	1.485	1.471	1.464	1.457	1.450
50	—	—	1.518	1.511	1.504	1.490	1.483	1.476	1.470
52	—	—	1.538	1.530	1.524	1.510	1.503	1.496	1.490
54	—	—	—	1.549	1.543	1.530	1.523	1.516	1.510
56	—	—	—	1.568	1.562	1.550	1.543	1.536	1.530
58	—	—	—	—	1.581	1.570	1.563	1.556	1.550
60	—	—	—	—	—	1.590	1.583	1.576	1.570
62	—	—	—	—	—	1.610	1.603	1.596	1.590
64	—	—	—	—	—	1.630	1.623	1.616	1.610
66	—	—	—	—	—	1.650	1.643	1.636	1.630
68	—	—	—	—	—	1.670	1.663	1.656	1.650
70	—	—	—	—	—	1.690	1.683	1.676	1.670
72	—	—	—	—	—	1.710	1.703	1.696	1.690
74	—	—	—	—	—	1.730	1.723	1.716	1.710

¹In g/ml

Data below 50% from Int. Crit. Tables, Vol. III, pg. 79. Data above 50% obtained by extrapolation.

Figure 4 Dilution Temperatures of Caustic Soda Solutions

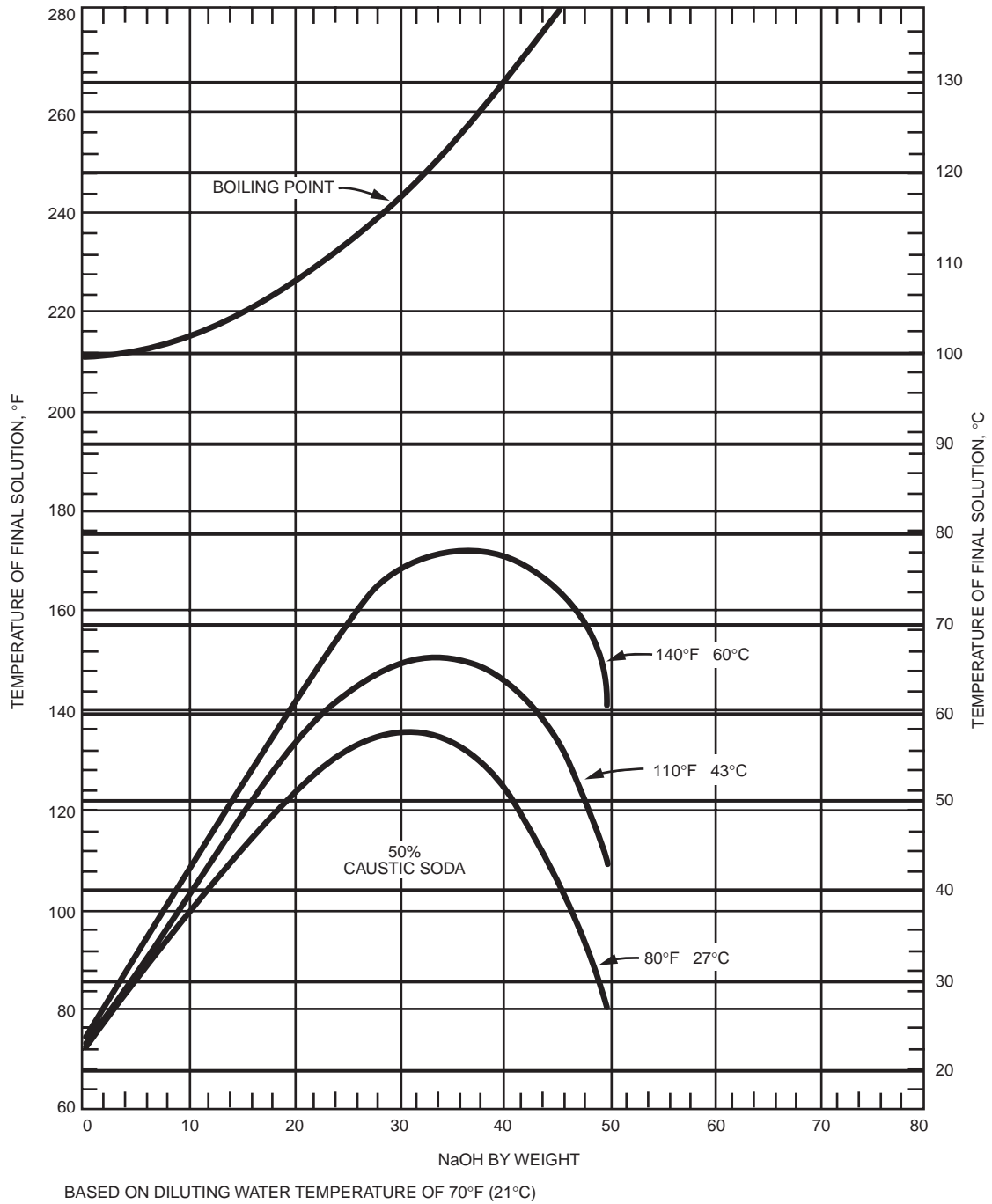
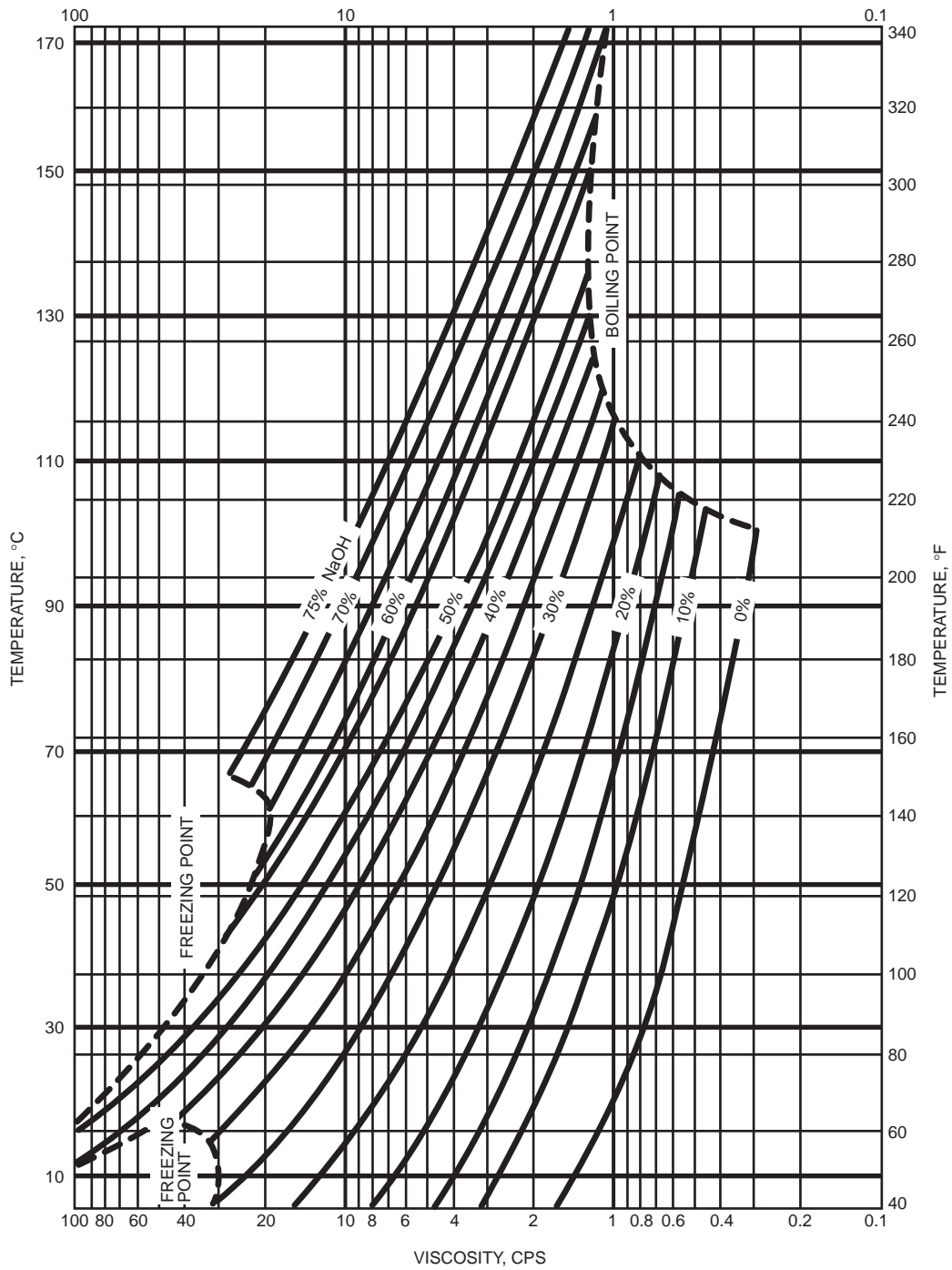
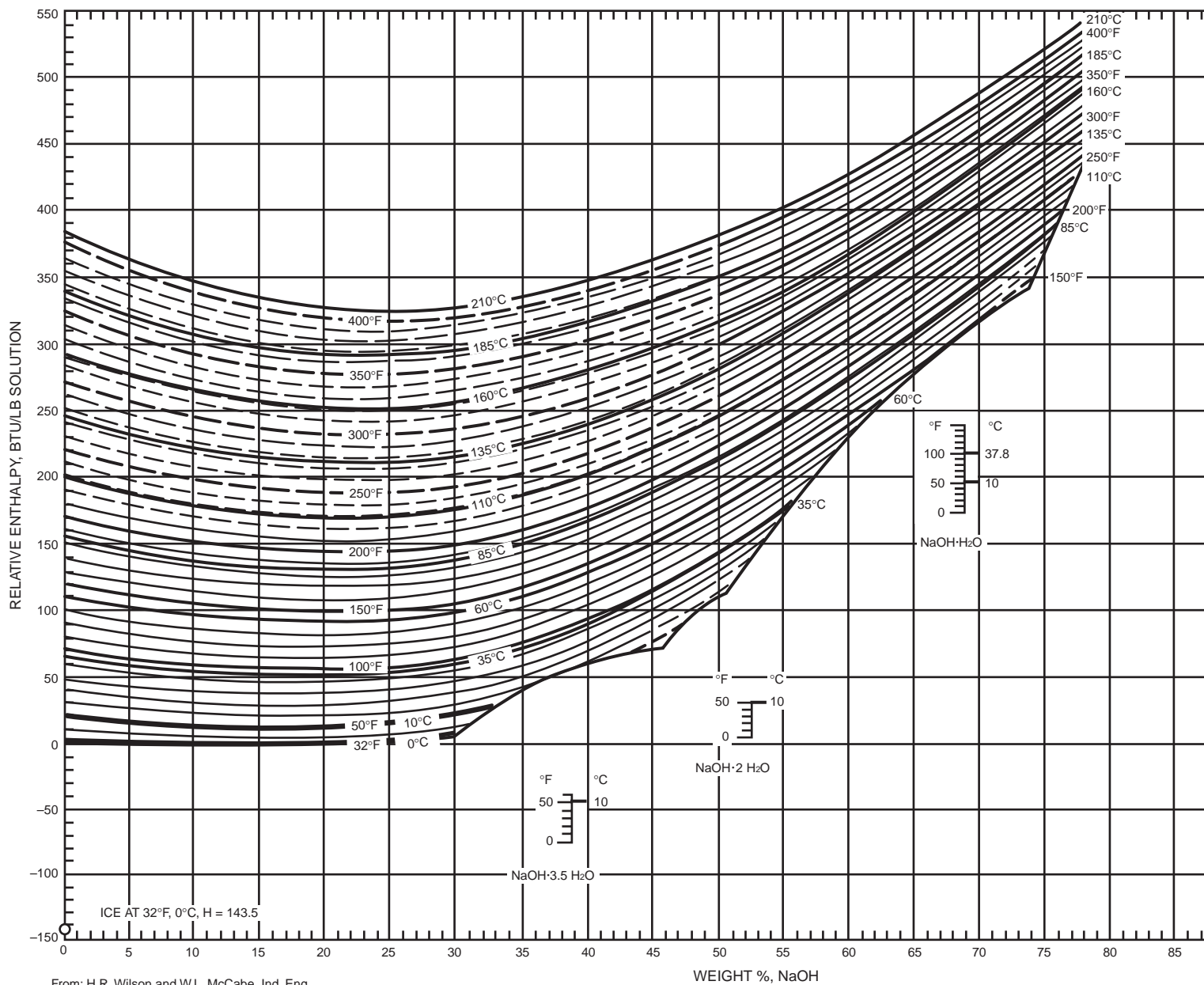

Figure 5 Viscosities of Caustic Soda Solutions



Data on Physical Properties

Figure 6 Enthalpy-Concentration Chart for Caustic Soda Solutions



From: H.R. Wilson and W.L. McCabe, Ind. Eng. Chem. 34,565 (1942). Used by permission.

**Method of Use: Enthalpy
(Relative Heat Content) Chart**

The chart at left may be used for heat of dilution calculations as illustrated in the following example:

A. To determine the amount of heat to be removed or added to change a given concentration of caustic soda solution from one temperature to another.

Problem: How many BTUs (calories) must be removed from each pound (gram) of solution to cool a 40% solution from 200°F (93°C) to 120°F (49°C)?

Solution: From the graph, the relative heat content of 40% caustic solution at 200°F (93°C) and 120°F (49°C) is found to be 177 Btu/lb and 110 Btu/lb, respectively. The amount of heat to be removed is the difference between these values, or 67 Btu/lb (120.7 CAL/GM) of solution.

NOTE: The chart on page 14 is derived from this enthalpy-concentration diagram. It is useful for determining the temperature of caustic soda solutions resulting from the dilution of commercial forms of caustic soda with water at the specified temperatures.

B. To determine the temperature of the final solution resulting from the dilution of a caustic soda solution, assuming no heat loss by radiation.

Problem: What is the temperature of the resultant 20% caustic solution obtained by using water at 80°F (27°C) to dilute 50% solution at 120°F (49°C)?

Solution: From the intersection of the 120°F (49°C) curve and the 50% caustic line, run a straight edge to the intersection of the 80°F (27°C) curve and the 0% line. The temperature of the 20% solution may be read at the point where the straight edge crosses the 20% line. It is found to be approximately 142°F (62°C).

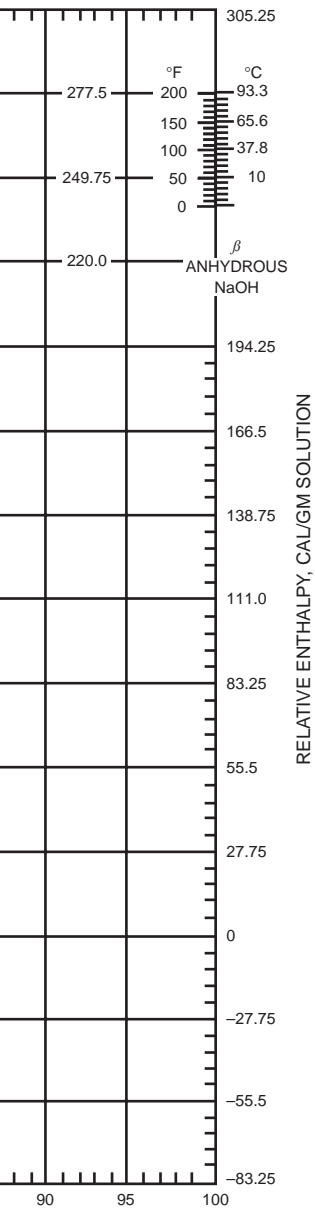
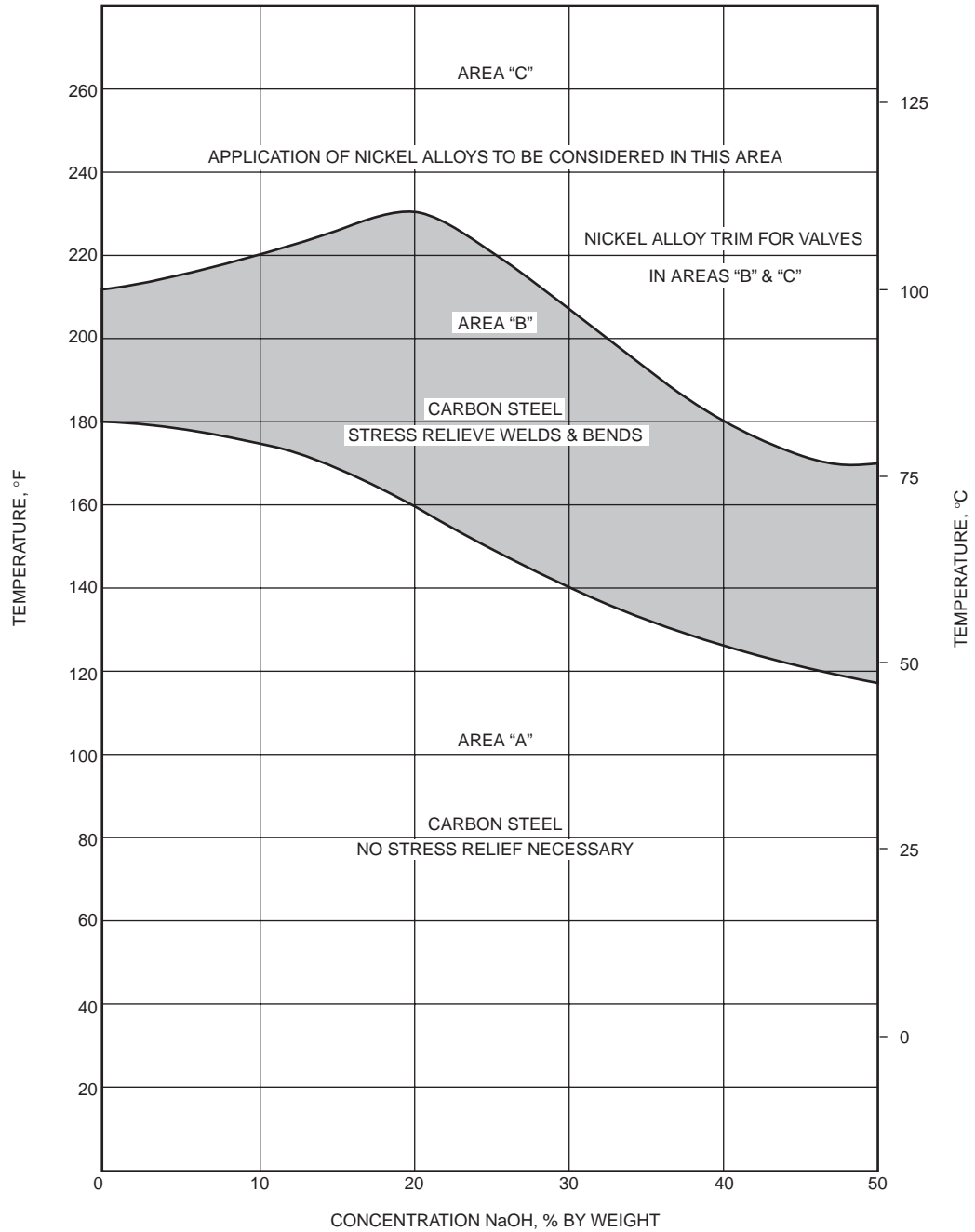

Figure 7 Caustic Soda Service Graph
 Metallurgical Requirements: Temperature vs. NaOH Concentration



From: NACE Corrosion Data Survey
 Fifth Edition, 1971

Storage and Handling

Caustic soda users are responsible for building and maintaining a properly designed storage and handling system. A trained design engineer is best equipped to design systems that maximize safety, while at the same time minimizing maintenance on the system. The initial capital cost must be secondary to these primary objectives. In the long term, a properly installed system that meets the objectives of safety and maintenance will usually be the least expensive.

For additional information on storage equipment and piping, review Pamphlet 094 from The Chlorine Institute. See page 3 for details.

The following are some suggestions for consideration, based upon our experience with producing caustic soda.

Design of Storage and Handling Systems

In designing the storage and handling system, three basic factors must be kept in mind: (1) caustic soda is highly corrosive and can be hazardous to personnel; (2) the viscosity of 50% caustic soda increases rapidly when its temperature falls below 65°F (16°C); and (3) the weight of caustic soda 50% solution is 1.5 times that of an equal volume of water.

Storage tanks should be located to minimize all piping, especially exterior pipes in which the caustic soda can freeze if a malfunction occurs in the heating equipment.

Of equal importance, however, is the need to locate storage and piping in a low-traffic zone to eliminate, as much as possible, potential exposure of workers.

Tank areas and pumps should be marked with warning signs at all entry points stating “Danger! Caustic Soda — Authorized Personnel Only.” Governmental regulations may require additional labeling. Governmental regulations may also require diking that can contain the maximum volume of NaOH stored in the tank.

Eyewash fountains and safety showers must be conveniently located and readily accessible to personnel in the unloading area and in other areas where maintenance or processing could expose workers to caustic soda. It is recommended that a horn or other such alarm device be installed at the safety shower so that it can be activated to summon help if use of the safety shower and/or eyewash fountain becomes necessary.

Self-draining and heated safety showers may be required in freezing conditions. Safety showers and eyewash fountains should be tested frequently, and especially before each unloading operation.

The unloading area should be designed to confine and collect drainage from the unloading hose and any leaks or drips from the unloading system valves.

Dow provides a Liquid Caustic Soda Safe Handling and First Aid Wall Chart. This poster covers protective clothing, precautions for unloading and handling, dilution procedures, and first aid recommendations. It is an effective piece to hang in caustic unloading and storage facilities to emphasize appropriate protective equipment. This poster can be ordered through our web site, www.dowcaustic.com.

Storage Tanks

Mild steel, butt-welded tanks are suitable for normal storage conditions. Welding should be done with appropriate rods such as those containing 1/2% molybdenum. Annealing to prevent stress corrosion cracking is not required unless temperatures greater than 120°F (49°C) are expected. (See Figure 7.)

If iron pickup from mild steel tanks is a problem, the tanks may be lined with a suitable caustic soda-resistant coating.

Vertical tanks are preferred over horizontal tanks since they take up less space and are easily supported on concrete slabs. Tank bottoms should be set in an asphalt grout for protection from exterior corrosion. All connections at the top of a tank should be grouped in one small area near the edge of the tank to permit servicing from a single location.

Storage tanks should be heated and insulated if sustained ambient temperatures below 65°F (18°C) are expected. The thickness of the insulation will depend upon the energy costs of heating. The insulation must be well-protected with jacketing to keep it dry.

Heating can be accomplished with steam coils or electrical heating tape. For internal tank heating, a nickel bayonet-type heat exchanger is recommended. The heater should be attached to a nickel flange, which can be fitted to a tank nozzle opening close to the bottom of the tank.

The horizontal heater should be supported about eight inches (20cm) above the bottom of the tank and extend across the storage tank to about one foot (30cm) from the opposite side. As the caustic soda solution around the heater is warmed, a thermal agitation pattern will form in the tank, resulting in uniform heating of all caustic soda solution. A maximum of 15 psig (104 kPa) steam is recommended for heating the caustic soda solution.

A temperature controller should be installed to maintain a caustic soda solution temperature of 85°–100°F (29°–38°C). The controller should include a high-temperature alarm and a thermocouple at the same liquid level as the steam coil. This guards against the thermocouple reading a false air temperature, causing the coils to overheat the remaining caustic solution when the tank is nearly empty. Another thermocouple located at eye level is convenient.

If a source of steam is not available, the storage tank can be heated using an electrical horizontal bayonet-type heat exchanger similar to the one described earlier. Also, the temperature of the caustic soda solution can be maintained or increased slowly using electrical heat-tracing tape attached to the outside of the storage tank. If electric heat-tracing tape is the only source of heat, the storage tank should be extremely well-insulated to ensure a minimum heat loss from the caustic soda solution.

Periodic cleaning and inspections (i.e., wall thickness testing) should be part of the storage tank preventive maintenance schedule.

In addition to a solution high-level alarm, the tank should have a liquid-level gauge and a vent. The vent should have a cross-sectional area at least four times that of the fill line (which is normally 2"), extending from the top of the tank to within about 3' of ground level. The vent, which also acts as an overflow, should be visible from the tank truck or tank car loading area so that personnel will see and/or hear caustic discharging from this overflow pipe in case the tank is overfilled.

Valves should never be installed in the vent line. It must be open to the atmosphere at all times. Sight glasses should never be used on 50% caustic soda solution storage tanks or transfer lines due to their potential for breaking or clouding.

Pipe and Fittings

Seamless carbon steel, butt-welded Schedule 40 pipe is recommended. Lined, flanged pipe has also been used successfully. All piping should be installed aboveground.

All process pipes should be heat traced and insulated if temperatures below 65°F (18°C) are anticipated for even short periods of time. Self-regulating electric heating tape is recommended. Other heating tapes or cables with thermostatic control may also be used. Steam tracing is not normally recommended since the temperature of caustic soda can readily exceed 140°F (60°C) under static conditions, causing eventual stress corrosion cracking (See Figure 7). Insulation and weatherproofing are also required if the piping must be heated.

If maintaining low iron concentration in the caustic soda solution is important, use a flanged steel pipe with a polypropylene lining (such as Moraf brand plastic-lined pipe which is suitable to 175°F [79°C]). Because of the hazardous properties of caustic soda, unsupported plastic pipe should never be used, and fiberglass reinforced plastic pipe should be used cautiously only for specific use conditions.

The entire piping system should be free-draining, if possible, to facilitate maintenance. Otherwise, capped drain valves should be installed at the lowest point in the system.

All piping systems should preferably be color coded and stenciled with "Caustic Soda" at least every ten feet.

Pumps

While steel or cast iron centrifugal pumps may be used for caustic soda solution, such pumps suffer high maintenance and short service life. For optimum service, Alloy 20 or its equivalent is preferred. All pumps should have a time-delay high pressure/low pressure switch downstream of the pump to prevent continued operation when the pump is dead-headed or running dry.

Whether a pump is equipped with a mechanical seal or packing gland is a matter of preference. However, product contamination by water used to purge mechanical seals can be a problem. Packing glands should not be used if "weeping" of caustic soda from a packing gland will create a safety hazard.

In addition to centrifugal pumps, positive displacement and other types of pumps are used for specific conditions. All major pump manufacturers specializing in chemical pumps have technically trained personnel who can assist in pump selection when pumping conditions can be defined. This is a service that should be fully utilized when the need arises.

Final System Testing

All new or repaired storage and handling systems should be water-tested under use conditions prior to introducing caustic soda solution into the system. It is much easier and safer to repair a water leak than a caustic leak!

The information contained above is not intended to be all-inclusive as it relates to use, handling, storage, disposal and all other described activities. Recipients must make their own determination of suitability and are responsible for compliance with all applicable federal, state, provincial, municipal laws and/or other regulations. This information is offered solely for your consideration and verification and in no event will The Dow Chemical Company be responsible for damages of any nature whatsoever resulting from the use or reliance upon this information or the product to which the information pertains.

Railway Tank Car Unloading

Precautions and Preliminary Procedures

1. All workers should be suitably clothed and equipped. (See Figure 1 — Protective Clothing and Equipment, page 4.)
2. Only workers who have been properly trained in the required safe handling and first aid procedures should be assigned to caustic soda service.
3. The unloading track should be level.
4. Once the car is spotted, set the handbrake and chock the wheels.
5. Metal caution signs and blue lights should be positioned on the track, preferably near the entering switch, at both ends of the car. These signs must not be removed until the car is unloaded and all fittings disconnected.
6. Unless the car is protected by a switch that is closed and locked, derails should be placed at the open end or ends of the siding not less than one car length from the car.
7. The surrounding area in which tank car unloading and transfer to storage takes place should be roped off and suitable warning signs installed.
8. Partly unloaded tank cars should not be moved if at all possible. If it should become necessary to move a partially unloaded car, close the internal and external outlet valves, drain the connecting lines, and disconnect all piping and hoses. If unloading by pressure, release the pressure on the tank car and lines before disconnecting. The dome cover must be closed and all bolt closures tightened securely before the tank car is moved.
9. Cars should be connected, unloaded, and disconnected in daylight, if at all possible. Adequate lighting should be provided if these operations must be done at night.
10. Before connecting the tank car to the unloading line, workmen should make sure that the storage tank is properly vented and that it will hold the entire contents of the car.
11. Under no circumstances should the customer's employees enter the car.
12. Cars should be unloaded over an appropriately designed spill containment area.
13. Wash off all spillage from the rail car thoroughly with water.

For additional information, review Pamphlet 087 from The Chlorine Institute. See page 3 for details.

Unloading Instructions — General

All Dow caustic soda tank cars are equipped with an eduction pipe and can be unloaded through the dome connections on top of the car using air pressure, or unloaded through the bottom discharge outlet valve.

Caustic soda solutions are normally unloaded through the bottom outlet valve using either air pressure or a centrifugal pump to transfer the solution to a storage tank.

If gravity flow to the pump inlet is used, the outlet valve in the piping from the transfer pump should be throttled to prevent cavitation on the suction side of the pump.

Unloading through the dome using air pressure is satisfactory for 50% NaOH, provided the total lift from the bottom of the car to the top of the storage tank is not more than 30 feet.

Confirming an Empty 50% Caustic Soda Solution Rail Car

To assure a 50% Caustic Soda Solution rail car has been completely emptied, it should be visually inspected.

1. Open vent valve to equalize pressure.
2. Open dome cover.
3. Visually confirm the residue caustic soda solution forms a liquid heel of no more than 1 foot wide.
NOTE: If a light is used for inspection, it should be explosion-proof rated due to the possibility that an explosive mixture of hydrogen and oxygen may be present in the car. DC powered lighting is recommended.
NOTE: To protect the light from falling into the car during the inspection, attach a rope or other means of retrieval to the light.
4. Prepare the empty tank car for return to Dow (see page 25). If more than a 12-inch wide heel is found, then additional caustic soda solution removal is required.

Top Unloading by Air Pressure

Figure 9 shows a typical layout for unloading caustic soda through the eduction pipe by air pressure.

Personal protective clothing and equipment must be worn throughout the preparation steps as well as during unloading. Eyewash fountains and safety showers should be checked for satisfactory operation before beginning the unloading operations.

1. Be sure the storage tank vent is clear and the tank has enough volume to hold the contents of the car.

2. Remove the protective housing covering the air inlet and eduction pipe valves on the top of the tank car.
3. Slowly and carefully open the valve on the 1" air inlet connection to relieve and equalize the pressure in the car.
4. Open the dome cover only if a retainer sample of 50% NaOH must be taken from the car.
5. If a retainer sample is taken, close the cover, making sure the dome latches are securely fastened before continuing.
6. Connect the unloading line to the discharge pipe valve connection.
7. Connect the air supply line to the air inlet valve located on the top of the tank car. Open the air inlet valve and apply air pressure to the car slowly. Typical air pressure is 30 psi.
8. Cautiously open the eduction pipe outlet valve until there is a suitable flow of caustic soda to the storage tank.
9. Check for leaks.
10. If a leak is found, close the eduction pipe outlet valve, stop the flow of pressurized air to the car, and relieve the air pressure on the car.
11. Eliminate all air or solution leaks by tightening or replacing the leaking piping or fittings.
12. Apply air pressure to the car slowly and open the eduction pipe outlet valve until there is a suitable flow of caustic soda to the storage tank.
13. Make air pressure adjustments, if needed, until the tank car is empty.
NOTE: A drop in pressure, or the sound of rushing air, indicates that the car is empty.
14. When the unloading line is completely drained, shut off the air supply line and allow the system to stand for a few minutes to relieve all internal pressure in the car. Let the discharge pipe drain.
15. Close the air inlet valve, de-pressure the air inlet line, then disconnect the air supply line fittings from the air inlet on the dome.
16. Close the eduction pipe outlet valve.
17. Visually inspect the car to confirm it is empty. See "Confirming an Empty 50% Caustic Soda Solution Rail Car" on page 21.
18. Clear and disconnect loading hose.
19. Clean out the unloading hose with steam or water inside the containment area.
20. Prepare the car for return to Dow. See page 25 for details.

Figure 8 Layout for Top Unloading Caustic Soda by Air Pressure

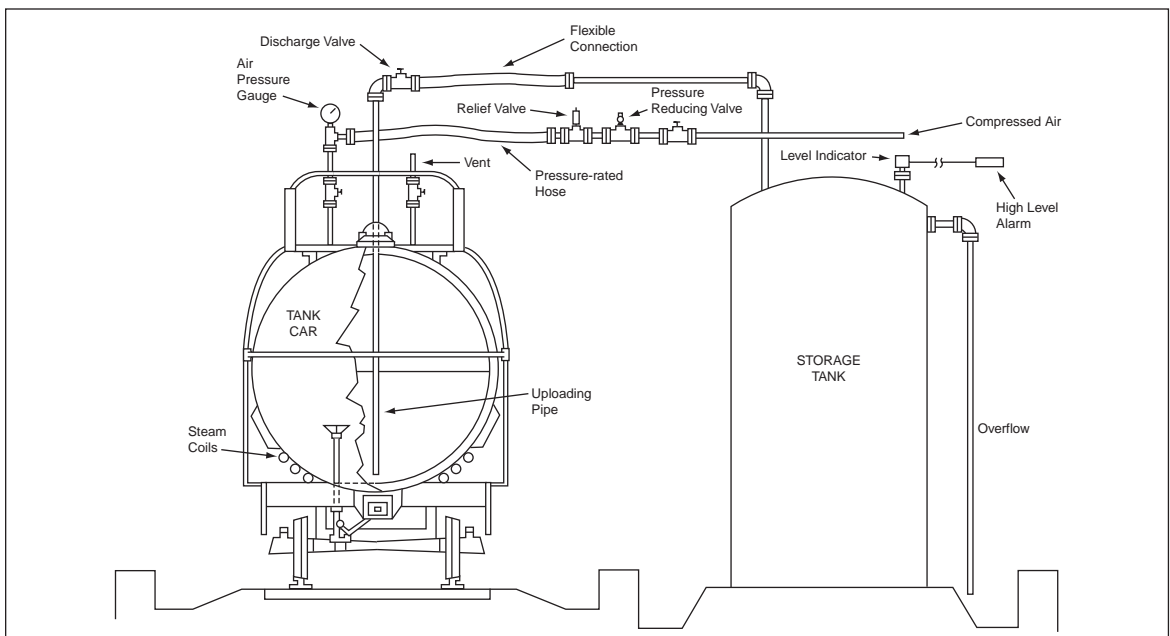

Unloading through Bottom Outlet Valve by Pump

Unloading by this procedure is recommended for 50% caustic soda solutions. Refer to Figure 9 for typical layout for unloading caustic soda solution by pump.

Personal protective clothing and equipment must be worn throughout the preparation steps, as well as during unloading. Eyewash fountains and safety showers should be checked for satisfactory operation before beginning the unloading operations.

1. Be sure the storage tank vent is clear and the tank has enough volume to hold the contents of the car.
2. Slowly and carefully open the valve on the 1" air inlet connection to relieve and equalize the pressure in the car.
3. Open the manway cover and assure that the valve remains slightly open during the unloading operation.
4. If necessary, heat the external bottom outlet valve and the 50% caustic solution thoroughly by connecting a steam line to the steam jacket on the bottom discharge fitting.
5. Cautiously remove the plug from the external bottom outlet valve. It may be necessary to use a second backup wrench to prevent the external bottom outlet valve from turning while removing the plug from the valve.
6. Attach the unloading line to the external bottom outlet valve.
7. Open the external bottom outlet valve.
8. Open the internal bottom outlet valve by turning the valve rod handle on the top of the tank car[†] and allow the 50% caustic soda to flow to the pump.
9. Check for leaks.
10. Shutdown as needed to correct leaks before proceeding to the next step.
11. Start the pump.
12. Recheck for leaks. Shutdown as needed to correct leaks during the offloading process.
13. When the tank car is empty, stop the pump and close the external bottom outlet valve and then the internal bottom outlet valve.
14. Visually inspect the car to confirm it is empty. See "Confirming an Empty 50% Caustic Soda Solution Rail Car" on page 21.
15. Clear and disconnect loading hose.
16. Clean out the unloading hose with steam or water inside the containment area.
17. Prepare the car for return to Dow. See page 25 for details.

Unloading through the Bottom by Air Pressure

Personal protective clothing and equipment must be worn throughout the preparation steps, as well as during unloading. Eyewash fountains and safety showers should be checked for satisfactory operation before beginning the unloading operations.

1. Be sure the storage tank vent is clear and the tank has enough volume to hold the contents of the car.
2. If necessary, heat the external bottom outlet valve and the 50% caustic solution thoroughly by connecting a steam line to the steam jacket on the bottom discharge fitting.
3. Remove the protective housing covering the air inlet and eduction pipe valves on the top of the tank car.
4. Slowly and carefully open the valve on the 1" air inlet connection to relieve and equalize the pressure in the car.
5. Open the dome cover only if a retainer sample of 50% NaOH must be taken from the car.
6. If a retainer sample is taken, close the cover, making sure the dome latches are securely fastened before continuing.
7. Cautiously remove the plug from the external bottom outlet valve. It may be necessary to use a second backup wrench to prevent the external bottom outlet valve from turning while removing the plug from the valve.
8. Attach the unloading line to the external bottom outlet valve.
9. Open the external bottom outlet valve.
10. Recheck to be sure the manway cover is fastened securely.
11. Connect the air supply line to the air inlet valve located on the top of the tank car. Open the air inlet valve and apply air pressure to the car slowly. Typical air pressure is 30 psi.
12. Open the internal bottom outlet valve by turning the valve rod handle on the top of the tank car[†] and allow the 50% caustic soda to flow.
13. Check for leaks.
14. If a leak is found, close the internal and external bottom outlet valves, stop the flow of pressurized air to the car, and relieve the air pressure on the car.
15. Correct all air or caustic soda solution leaks by tightening or replacing the leaking piping or fittings.

[†]If the outlet valve handle does not turn with moderate pressure, it indicates that some frozen caustic soda remains in the bottom of the car and further steam is necessary. DO NOT ATTEMPT TO FORCE THE HANDLE.

16. Apply air pressure to the car slowly. Open the external bottom outlet valve and then the internal bottom outlet valve until there is a suitable flow of caustic soda solution to the storage tank.
17. Make air pressure adjustment, if needed, until the tank car is empty.
NOTE: A drop in pressure, or the sound of rushing air indicates that the car is empty.
18. When the unloading line is completely drained, shut off the air supply line and allow the system to stand for a few minutes to relieve all internal pressure in the car. Let the discharge pipe drain.
19. Close the air inlet valve, de-pressure the air inlet line, then disconnect the air supply line fittings from the air inlet on the dome.
20. Close the internal bottom outlet valve and the external bottom outlet valve.
21. Visually inspect the car to confirm it is empty. See "Confirming an Empty 50% Caustic Soda Solution Rail Car" on page 21.
22. Clear and disconnect loading hose.
23. Clean out the unloading hose with steam or water inside the containment area.
24. Prepare the car for return to Dow. See page 25 for details.

Figure 9 Layout for Bottom Unloading 50% Caustic Soda Solution by Pump

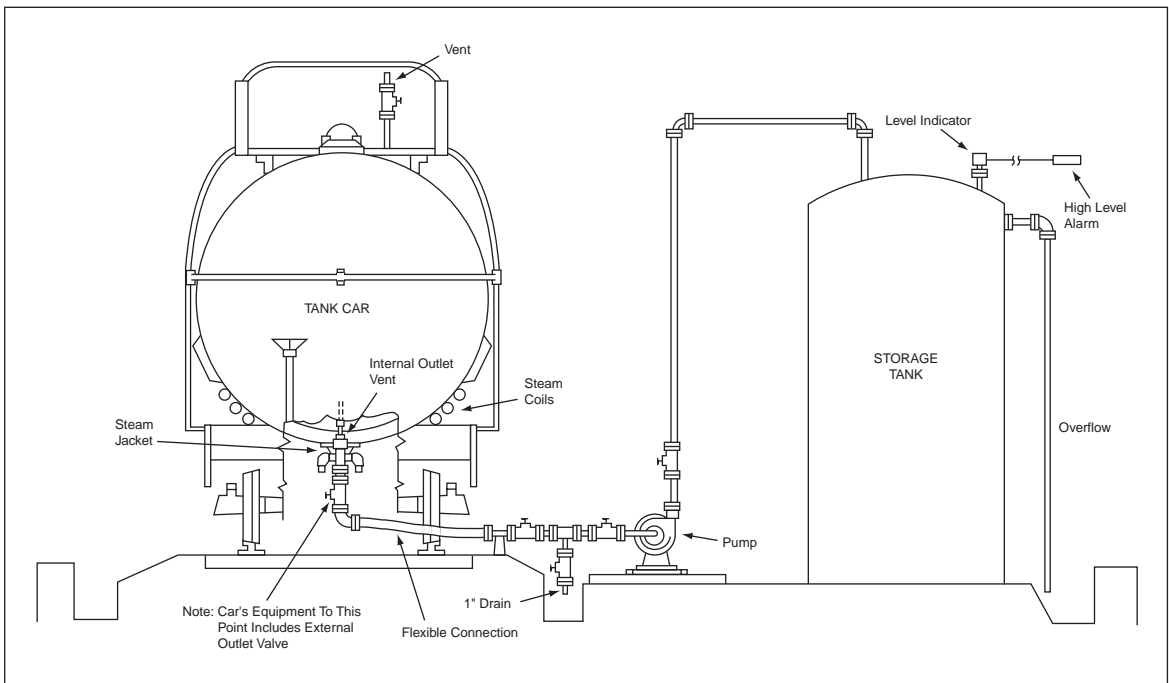

Tank Truck Unloading

Preparing the Empty Tank Car for Return to Dow

Once the tank car has been unloaded, it should be promptly returned. Dow's routing directions should always be followed. If routing directions have not been released, call your Dow representative for specific instructions.

The following procedures should be carefully followed in preparing the empty tank car for return:

1. Disconnect the steam lines and blow out the heating coils with compressed air.
2. After removing all connections, replace the closures on all tank openings. Fasten dome cover securely.
3. While inside a containment area, wash the unloading lines or hoses and any minor spills on or around the tank car with water.
4. In Canada, under the current Transport Canada, Transport of Dangerous Goods (TDG) regulations, where a residue placard is required for DOMESTIC SHIPMENTS of regulated products by rail, the RESIDUE placard must be displayed on the tank car for the dangerous goods last contained therein.

This requirement will continue to be in effect until the TDG "Clear Language" regulations become effective August 15, 2002. After August 15, 2002, the requirement to display the residue placard will be discontinued.

Procedures for unloading tank trucks are similar to those for unloading tank cars except that pressures and fitting locations may vary from truck to truck. The unloading operator should verify the location of all fittings before unloading. The driver of the truck should be familiar with these locations. We suggest you discuss with the driver the specifics of his vehicle before beginning unloading operations.

The driver of the caustic soda tank truck is usually responsible for his own unloading, requiring only a 2" male connector on the customer's permanent unloading system. Remember: It is your responsibility to sign off that the driver has attached the unloading hose to the proper tank and that the tank has adequate empty space to hold entire contents of the truck.

The tank truck unloading operator should wear the same protective equipment and obey the safety precautions as outlined on pages 4–5 of this Handbook. Close-fitting chemical worker's safety goggles and chemical resistant gloves, as a minimum, must always be worn while handling caustic soda solution. In addition to the minimum personal protective equipment, a chemical protective suit (jacket and pants), hard hat with full face shield (in addition to chemical worker's goggles), and chemical resistant boots are required while connecting and disconnecting hoses and during the start-up of the transfer process.

A safety shower and eyewash fountain must be provided. These should always be tested prior to hookup and before unloading commences.

It is common practice to unload by air, which is normally provided by the customer, but which also may be provided by the trucker (Figure 10). For discharge elevations above 30', it is recommended the caustic soda be unloaded by using a pump provided by the customer, or by the trucker if he is notified in advance (Figure 11).

Once the unloading is completed, water must be available so that the trucker can wash out and dilute any caustic soda remaining in his unloading hose, as well as minor spills. Collection facilities should be provided to handle spills and wash out streams.

Remember: During cold weather operations, tank trucks have no heating coils. When the contents of the truck cool down, the viscosity of 50% NaOH increases rapidly. At higher viscosities, the unloading pump discharge pressure may not be high enough to overcome the elevation head required to pump into the storage tank.

For additional information, review Pamphlet 088 from The Chlorine Institute. See page 3 for details.

Figure 10 Tank Truck Top Unloading Caustic Soda by Air Pressure

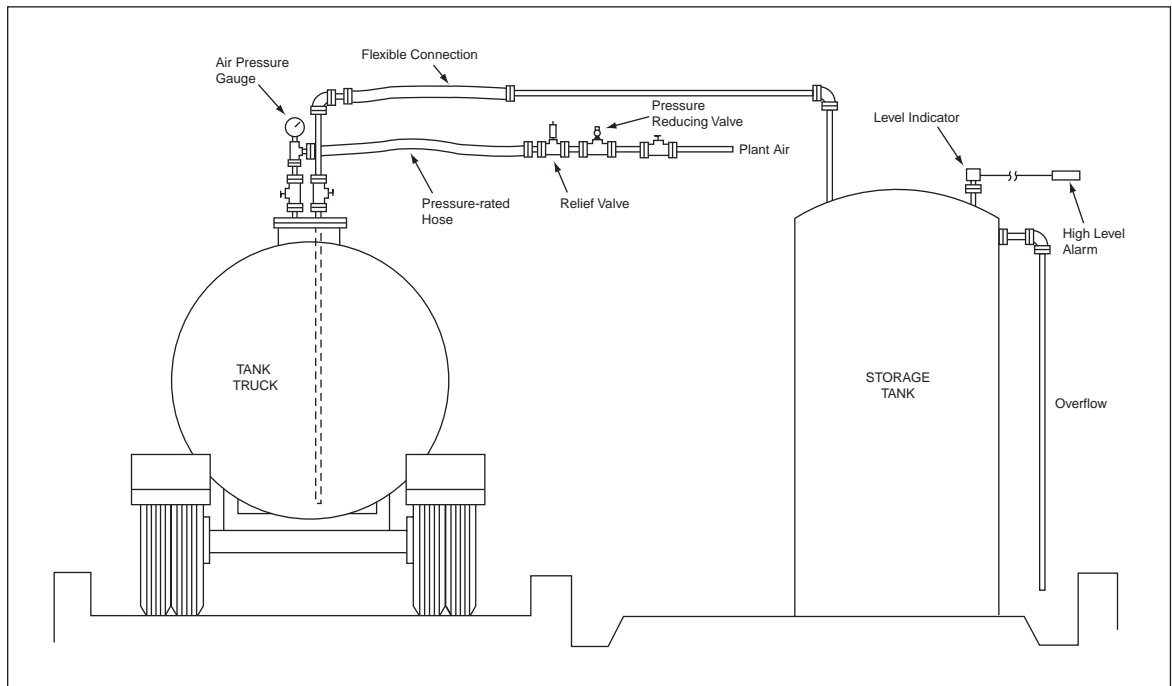
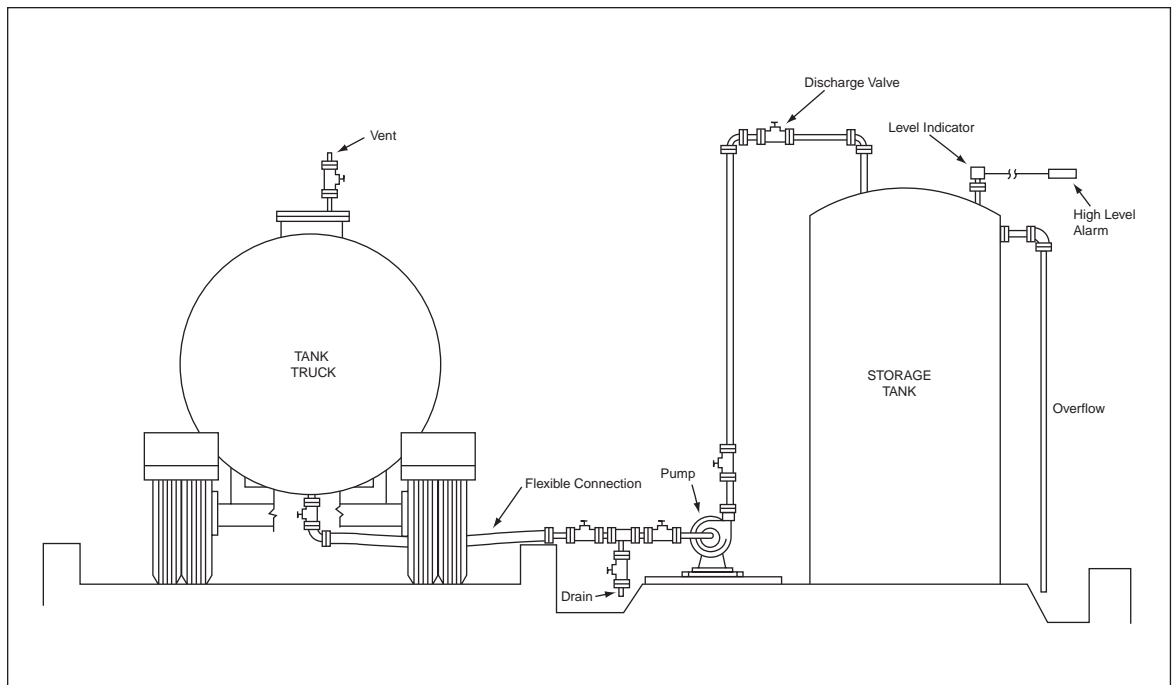

Figure 11 Tank Truck Bottom Unloading Caustic Soda by Pump



Railway Tank Car Steaming

Tank cars in Dow caustic soda service are insulated to help prevent freezing. However, since commercial solutions do freeze at fairly high temperatures [50% solution begins to freeze at about 60°F (15°C)] transit delays during cold weather may cause some freezing. Therefore, it is always a good idea to check the solution temperature before unloading.

If the temperature of a shipment of 50% solution is above 85°F (29°C), it can generally be unloaded without steaming. If the temperature is below 65°F (18°C), steaming is almost always necessary. Between 65°F (18°C) and 85°F (29°C), it is often a good idea to heat the car to reduce the viscosity of the solution for easier and faster unloading.

Key Points for Thawing Caustic in Tank Cars

Many times it is not necessary to heat the entire tank car because it is not the contents of the car that restricts the unloading, but caustic which has frozen around the outlet valve. As a first step to steaming a caustic car, it is only necessary to steam the area around the outlet valve with a steam lance. If after this is completed the caustic still is not able to be pumped, it may mean heating the contents of the car. All cars used to ship Dow's caustic contain steam coils which enable customers to safely and easily heat the contents of the car. Using the guidelines below, this operation can be completed safely and effectively.

- As with any unloading operation for caustic soda solution, proper safety equipment should be worn. This includes close-fitting chemical worker's safety goggles, chemical resistant gloves, and a hard hat as minimum protection. (See page 4 for more information.)
- To avoid pressure building up in the car, the car must be vented. This can be done by opening the manway cover or the vent valve on the top of the car.
- Steam supply must be regulated down to 15 psig to prevent damage to car liner.
- A steam trap should be installed on the outlet steam coil to maximize heating efficiencies.
- Continued heating after the caustic soda is liquefied will waste steam and may damage the special lining on the inside of the car. The temperature of 50% NaOH solution should never exceed 150°F (66°C) in lined cars.

Never apply heat by blowing steam directly into a lined car without the express permission of Dow. Lined cars must not be used as mixing tanks.

Once the caustic soda is completely thawed, the car is ready for sampling and unloading. Shut off and disconnect steam lines to coil before starting the unloading procedure.

CAUTION: Continued steaming of the coils after the solution falls below the heating coil surface will destroy the lining in the tank car. In extremely cold weather, continue steaming the external bottom outlet leg until caustic flow to storage has begun.

In cold weather, it is usually necessary to preheat the unloading lines to prevent the lines from plugging. This can be done with a maximum of 15 psi (103 kpa) steam tracing or by electrical heat tracing. Either way, the unloading line should be well insulated.

All horizontal portions of the unloading line leading to the top of the storage tank should be free-draining toward the tank. This will assure that this portion of the unloading line is empty except when unloading.

Summary

Caustic soda solution is a highly corrosive material. It is also an important raw material in the manufacture of a wide variety of valuable products.

This manual provides a number of warnings regarding the possible consequences of improper handling and storage of caustic soda solution. It also provides recommendations for proper procedures and practices.

Through Dow's Responsible Care efforts, customers can receive a variety of materials, from MSD sheets to a safe handling video presentation, that augment and reinforce the safe handling information provided in this manual. These materials combined represent an excellent starting point for customers to develop their own caustic soda stewardship programs . . . to put into place the procedures for handling, using, storing, and disposing of caustic soda safely and responsibly.

For more information on the safe handling of DOW caustic soda, visit our web site www.dowcaustic.com, contact your Dow sales representative, or call the number for your area listed on the back of this brochure.



WWW.PETRODMO.COM



Petro Chemical
Supplying Co.

WWW.PETROCSC.COM



WWW.PETROGROUPCO.COM

For more information

Visit : www.petrocsc.com

Call: 00982122147345-6

Responsible Care®
Good Chemistry at Work

Notice: No freedom from any patent owned by Seller or others is to be inferred. Because use conditions and applicable laws may differ from one location to another and may change with time, Customer is responsible for determining whether products and the information in this document are appropriate for Customer's use and for ensuring that Customer's workplace and disposal practices are in compliance with applicable laws and other governmental enactments. Seller assumes no obligation or liability for the information in this document. NO WARRANTIES ARE GIVEN; ALL IMPLIED WARRANTIES OF MERCHANTABILITY OR FITNESS FOR A PARTICULAR PURPOSE ARE EXPRESSLY EXCLUDED.

Published January 2004.

Living.
Improved daily.

Responsible Care® is a registered service mark of The American Chemistry Council.

 Printed in U.S.A.

*Trademark of The Dow Chemical Company

Form No. 102-00011-104AMS